

# IX-B015S6 (SUS316)

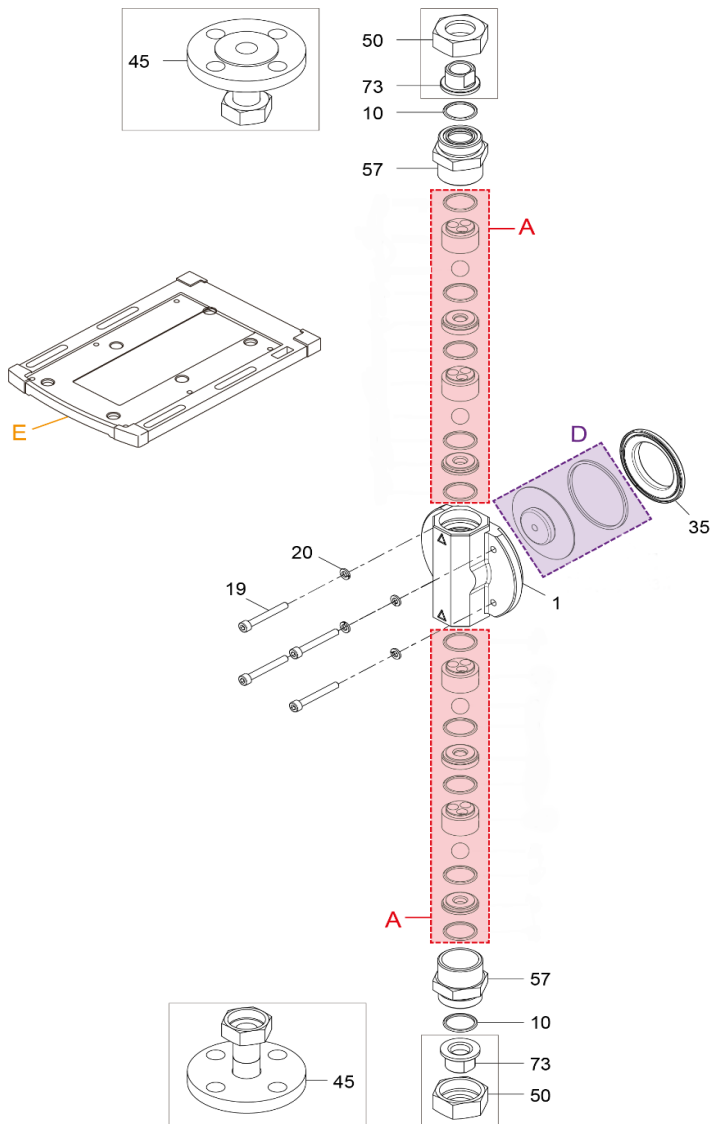

Item	Description	Q'ty	Remark	Part No.		
1	Pump Head	1	SUS316	IX0365		
10	Gasket	2	PTFE	IX0354		
A	Valve Set	2		IX0364		
19	Hex. Socket Head Bolt	M5x40	4	SUS316L	IX0356	
20	Spring Washer	M5	4	SUS316L	IX0264	
D	Diaphragm Set	1		IX0298		
35	Bracket Spacer	1	GFRPP	IX0297		
45	Flange Unit	JIS 10K 15A	'FJ'	2	SUS316	IX0357
		DIN PN10 DN15	'FD'	2	SUS316	IX0358
		ANSI 150lb 1/2"	'FA'	2	SUS316	IX0359
50	Nut	'R' • 'N'	2	SUS316	IX0360	
57	Adapter	2	SUS316	IX0361		
73	Fitting	Rc 3/8"	'R'	2	SUS316	IX0362
		3/8" FNPT	'N'	2	SUS316	IX0363
E	Base	1	GFRPPE	IX0333		

⚠ Subject to change without prior notice! ⚠ Actual pump may differ from the exploded view!